

Amana

Use and Care Guide Home Laundry Automatic Washer

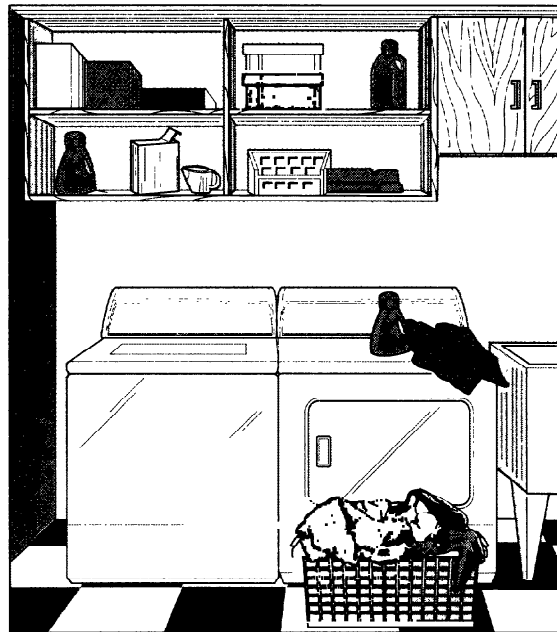

D310E3B

KEEP THESE INSTRUCTIONS FOR FUTURE REFERENCE. (If the washer changes ownership, be sure this manual accompanies the washer.)

**Part No. 38643R3
November 1997**

Table of Contents

Important Safety Instructions	3
Before Washing	
Prepare Wash Load	5
Sort	5
Pretreat	5
Loading the Washer	
Load Articles	6
Load Sizes	6
Water Level	6
Water	
Water Hardness	7
Iron	7
Wash Temperature	7
Laundry Tips	8
Washing Temperature Guide	9
Optional Features	
Bleach Dispenser	10
Agitator Cap	10
Fabric Softener Dispenser	10
Special Care	
Starching	11
Knits	11
Permanent Press	12
Washing Special Items	13
Washing Problems	14
Stain Removal	15
Maintenance	
Cold Weather Care	18
Care Of Your Washer	18
Vacations and Extended Non-Use	18
Reinstallation of Shipping Materials	18
Motor Overload Protector	18
Before You Call For Service	19
If Service Is Required	19
Factory Service Center	20
Information For Handy Reference	Back Cover

	WARNING
<p>FOR YOUR SAFETY and to reduce the risk of fire or an explosion, do not store or use gasoline or other flammable vapors and liquids in the vicinity of this or any other appliance.</p>	
	<small>W022</small>

IMPORTANT SAFETY INSTRUCTIONS

(Save These Instructions)

	WARNING
<p>To reduce the risk of fire, electric shock, serious injury or death to persons when using your washer, follow these basic precautions:</p>	
<p style="text-align: right;">W023</p>	

1. Read all instructions before using the washer.
2. Refer to the **GROUNDING INSTRUCTIONS** in the **INSTALLATION** manual for the proper grounding of the washer.
3. Do not wash articles that have been previously cleaned in, washed in, soaked in, or spotted with gasoline, dry-cleaning solvents, other flammable or explosive substances as they give off vapors that could ignite or explode.
4. Do not add gasoline, dry-cleaning solvents, or other flammable or explosive substances to the wash water. These substances give off vapors that could ignite or explode.
5. Under certain conditions, hydrogen gas may be produced in a hot water system that has not been used for two weeks or more. **HYDROGEN GAS IS EXPLOSIVE.** If the hot water system has not been used for such a period, before using a washing machine or combination washer-dryer, turn on all hot water faucets and let the water flow from each for several minutes. This will release any accumulated hydrogen gas. **THE GAS IS FLAMMABLE, DO NOT SMOKE OR USE AN OPEN FLAME DURING THIS TIME.**
6. Do not allow children to play on or in the washer. Close supervision of children is necessary when the washer is used near children. This is a safety rule for all appliances.
7. Before the washer is removed from service or discarded, remove the lid to the washing compartment.
8. Do not reach into the washer if the washtub or agitator is moving.
9. Do not install or store the washer where it will be exposed to water and/or weather.
10. Do not tamper with the controls.
11. Do not repair or replace any part of the washer, or attempt any servicing unless specifically recommended in the user-maintenance instructions or in published user-repair instructions that you understand and have the skills to carry out.
12. To reduce the risk of an electric shock or fire, **DO NOT** use an extension cord or an adapter to connect the washer to the electrical power source.
13. Use your washer only for its intended purpose, washing clothes.
14. **ALWAYS** disconnect the washer from electrical supply before attempting any service. Disconnect the power cord by grasping the plug, not the cord.
15. Install the washer according to the **INSTALLATION INSTRUCTIONS**. All connections for water, drain, electrical power and grounding must comply with local codes and be made by licensed personnel when required. Do not do it yourself unless you know how!
16. To reduce the risk of fire, clothes which have traces of any flammable substances such as vegetable oil, cooking oil, machine oil, flammable chemicals, thinner, etc. or anything containing wax or chemicals such as in mops and cleaning cloths, must not be put into the washer. These flammable substances may cause the fabric to catch on fire by itself.
17. Do not use fabric softeners or products to eliminate static unless recommended by the manufacturer of the fabric softener or product.

18. **Keep your washer in good condition. Bumping or dropping the washer can damage safety features. If this occurs, have your washer checked by a qualified service person.**
19. **Replace worn power cords and/or loose plugs.**
20. **Be sure water connections have a shut-off valve and that fill hose connections are tight. CLOSE the shut-off valves at the end of each wash day.**
21. **Loading door MUST BE CLOSED any time the washer is to agitate or spin. DO NOT by-pass the loading door switch by permitting the washer to agitate or spin with the loading door open. A brake will stop the washtub within seconds if the loading door is opened during spinning. If the washtub does not stop when the loading door is opened, remove the washer from use and call the service person.**
22. **Always read and follow manufacturer's instructions on packages of laundry and cleaning aids. Heed all warnings or precautions. To reduce the risk of poisoning or chemical burns, keep them out of the reach of children at all times (preferably in a locked cabinet).**
23. **Always follow the fabric care instructions supplied by the garment manufacturer.**
24. **Never operate the washer with any guards and/or panels removed.**
25. **DO NOT operate the washer with missing or broken parts.**
26. **DO NOT by-pass any safety devices.**
27. **Failure to install, maintain, and/or operate this machine according to the manufacturer's instructions may result in conditions which can produce bodily injury and/or property damage.**

NOTE: The WARNING AND IMPORTANT SAFETY INSTRUCTIONS appearing in this manual are not meant to cover all possible conditions and situations that may occur. Common sense, caution and care must be exercised when installing, maintaining, or operating the washer.

Always contact your dealer, distributor, service agent or the manufacturer about any problems or conditions you do not understand.

Before Washing . . .

Prepare Wash Load

Empty Pockets and Cuffs

Make sure all pockets are empty and turn them inside out. One bobby pin, metal or plastic toy, nail or sharp object in a load can catch laundry and cause tears. Facial tissue left in a pocket will produce extreme “lint”. A crayon or lipstick in a wash load may cause stains that cannot be removed. Roll down cuffs and shake out grass, sand, and gravel.

Mend Rips and Tears

Little holes can become bigger in the washer. Mend holes and tears before placing garments in the washer.

Close Zipper and Fasten Hooks

These can catch on garments in a wash load and tear them. Tie belts and sashes so they won't wind around clothes.

Remove Nonwashable Trim

Check for colorfastness by squeezing a portion of garment in warm or hot sudsy water. If the color bleeds or runs, wash the item separately in cold water.

Sort

Proper sorting is easy if you follow a few guidelines:

1. Sort by Color

Whites

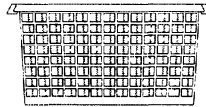

Lights



Darks

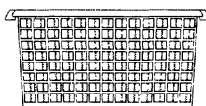

Non-Colorfast

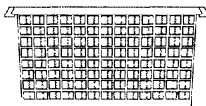

W3081E0A

2. Sort by Fabric and Construction

Cottons and Linens

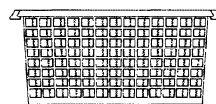

Synthetics, Blends & Poly Knits



Permanent Press

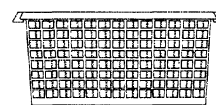

Delicates

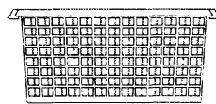

W3091E0A

3. Sort by Care Label

Cold

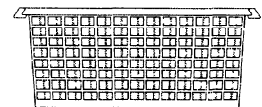

Warm

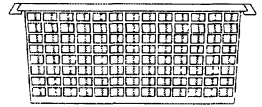

Hot

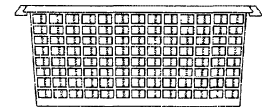

W3101E0A

4. Sort By Type and Amount of Soil

Children's play clothes, as well as work clothes, will need extra treatment. Lightly soiled clothes can become dingy if washed with heavily soiled items.

5. Sort Lint “Shedders” From Lint “Receivers”

Some fabrics attract lint and should not be washed with lint-shedding loads. Lint shedders are cottons, terry towels, chenille bedspreads, rugs, and clothes which have been heavily bleached.

Lint receivers are synthetics, permanent or durable press, knits (including socks), corduroy, and other smooth fabrics.

Pretreat

Pretreat shirt collars and cuffs with a pre-wash product or liquid detergent when placing them in the washer. Before washing, treat special stains with bar soap, liquid detergent or a paste of water and granular detergent. Use a pretreat soil and stain remover.

Loading the Washer . . .

Load Articles

Load items by the amount of space they take up, not by their weight. Mix large and small items in a load to get the best washing results.

Drop items loosely into the washtub. The bulk of the clothes rather than the weight will determine load size. Do not pack items in or wrap them around the agitator. Overloading can cause poor cleaning, excessive wrinkling, and tears.

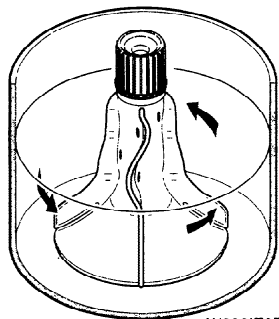

W2801E0B

Items should move freely through the wash water for best cleaning results. Items should rollover, sink and then reappear.

When washing very large items, do not fill washtub as full as with other loads.

Load Sizes

Small

- 3-4 perm. press dress shirts
- OR
- 1 twin sheet, 1 pillow case
- OR
- 1-2 lightweight dresses

Medium

- 6-7 perm. press shirts
- OR
- 2 twin sheets, 2 pillow cases
- OR
- 8 standard bath towels, 6 wash cloths

Large

- 10-11 perm. press shirts
- OR
- 2 full size sheets, 2 pillow cases, 2 pair men's pajamas
- OR
- 12 standard bath towels, 4 hand towels, 4 wash cloths

Extra Large (OPTIONAL)

- 8-9 shirts and 5 pair polyester pants
- OR
- 2 queen size sheets, 4 pillow cases, 2 nightgowns
- OR
- 1 pair men's pajamas
- OR
- 1 queen size bedspread

Reset (OPTIONAL)

Use the RESET if agitation has started and more water is needed for the load.

Water Level

Right

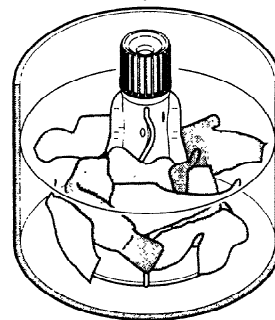

W2811E0C

Wrong

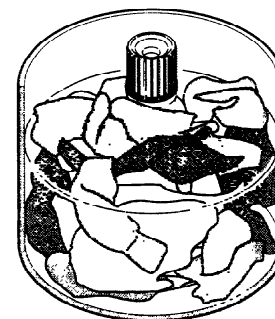

W2821E0B

NOTE: Illustrations shown with fabric softener dispenser. Your washer may have an agitator cap.

The water level in your washer should fit the size of your wash load. Small loads will use lower water levels. There must be enough water in the washtub to allow items to move and turn over freely.

Overloading the washtub can result in poor washing and rinsing.

Overloading may also cause wrinkling and tearing of items.

IMPORTANT: If in doubt always use a higher water level. Most average loads will require water setting of *Large*. Failure to have the correct volume of water relative to the load will increase the incidence of excessive lint.

Water . . .

Water Hardness

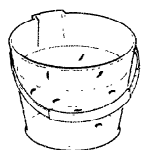

Soft Water
0 to 10 milligrams
per liter

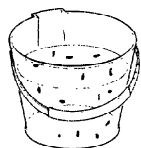

**Moderately Hard
Water**
300 milligrams
per liter

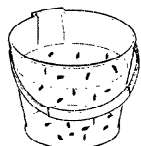

Hard Water
500 milligrams
per liter

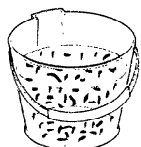

Very Hard Water
Over 500 milligrams
per liter

W1201E0B

Water hardness is measured in grains per gallon (G.P.G.) or parts per million (P.P.M.). To learn your water hardness, call your Water Department or State Extension Service. Hard water will not remove soil as well as soft water and can result in gray, dingy laundry. To get clothes clean in hard water, use a phosphate detergent or use more detergent if using a non-phosphate detergent. Do not use soap.

Hard Water May Be Softened By:

1. A mechanical water softener installed in your home.
2. The use of a packaged water conditioner.

Soft Water

Water should be soft enough to allow soaps and detergents to remove soil effectively. Clothes will be whiter and brighter when washed and rinsed in soft water.

Iron

If iron is present in the water, the clothes may become an all-over yellow or they may be stained with brown or orange spots or streaks. Iron is not always visible in the water.

Solutions to Iron Problems

The installation of a water softener will remove small amounts of iron from the water supply. The installation of an iron filter may be necessary for more severe cases. If the iron comes from the pipes, it may be sufficient just to let the water run into the empty washer for about one minute. This may help to clear the pipes. Spin this water out of the washtub before starting the wash.

If iron comes from the water heater, drain the heater occasionally to remove the rust.

If the Iron Condition Cannot Be Corrected

Prepare the wash water first by adding detergent (not soap), then add the clothes to the washtub. Use a phosphate detergent. The phosphate content of a detergent is listed on the package side panel.

Add a nonprecipitating water conditioner to the washtub just before the rinse water enters. Do not use fabric softener in the rinse water if a packaged water conditioner is used.

Iron With Chlorine Bleach

The use of chlorine bleach with water that contains iron will make the rust discoloration worse. Use an "all fabric" bleach.

Wash Temperature

Hot Water

Hot water will give the best results of cleaning and sanitizing, but it is not suitable for all items. It is best for sturdy whites and colorfast items, heavily soiled items and diapers.

Warm Water

By using warm water, there is less chance of color loss in items. Warm water also reduces wrinkling in permanent press items. Use with light and moderate soils, non-colorfast or dark colors, permanent press, silks, woolsens, nylon, and acrylic.

Cold Water

Cold water is less effective in cleaning than hot or warm water, but it does minimize wrinkling and color fading. Use it for washing extra-sensitive clothes and for the rinsing of all fabrics.

Energy

You can save energy when washing by following a few guidelines:

1. Heating water accounts for the greatest energy expense when washing. Save on heating water by using cold rinses.
2. Wash full loads, but do not overload.
3. Use soak cycles for heavily soiled items to reduce wash times.
4. Select a shorter wash time for lightly soiled items.

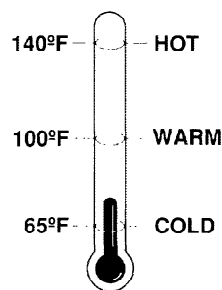

W1211E0A

Laundry Tips . . .

Laundry Aids	Use	Comments
Soak/Pretreat Products	<ul style="list-style-type: none"> • Use a soaking agent and follow steps under “Soaking” in your Operating Instructions insert or soak overnight to remove stains and soils. • Always follow manufacturer’s instructions with any pretreatment product. 	<ul style="list-style-type: none"> • Do not use a soaking agent with chlorine bleach. • Do not use pretreaters around the washer or dryer control panel. They may harm the finish or panel markings.
Detergents/ Soaps	<ul style="list-style-type: none"> • You may use detergent or soap in your washer. The determining factor is the hardness of the water. Always use detergent if the water is over three grains hard. 	<ul style="list-style-type: none"> • Soap and nonphosphate powdered detergents will not give good washing results in hard water. Soap in hard water will form sticky deposits. • The use of powdered soap is not recommended when washing in cold water.
Bleaches	<ul style="list-style-type: none"> • Use to remove certain stains, disinfect, and keep clothes white. • Use bleach in the wash water only. Do not use bleach in the rinse. • Follow directions on care label of garment. • Bleach should not be used as a substitute for detergent. Use the recommended amount of bleach. 	<ul style="list-style-type: none"> • When using liquid chlorine bleach, always use the bleach dispenser. • Always measure the bleach. Never exceed one cup of bleach per full load. • Never use chlorine bleach and ammonia in the same wash cycle.
Fabric Softeners	<ul style="list-style-type: none"> • Use to soften clothes and remove static electricity from permanent press knits and other fabrics of man-made fibers. • Add during the rinse cycle, or if available, use the fabric softener dispenser, using no other product in the rinse. Follow bottle directions carefully. 	<ul style="list-style-type: none"> • Undiluted fabric softener poured directly on clothes can stain them. • Do not mix with detergent or bleach.
Water Conditioners Non-Precipitating Type Precipitating Type	<ul style="list-style-type: none"> • These products soften water by tying up the hardness minerals. Recommended if using soap with water over three grains hard, or when using nonphosphate detergents. • These products settle out hardness minerals by converting them into particles that will not dissolve in the water. If used with nonphosphate detergent or soap in hard water, a deposit may form on the clothes and washer parts. 	<ul style="list-style-type: none"> • Do not use with nonphosphate detergents or soaps.

Washing Temperature Guide . . .

Water Temperature	Use	Comments
HOT (approx. 140° F)	<ul style="list-style-type: none"> • Sturdy whites and colorfast items. • Work clothes. • Soiled items. • Diapers. 	<ul style="list-style-type: none"> • Best cleaning for heavily soiled items. • Best for sanitizing.
WARM (approx. 100° F)	<ul style="list-style-type: none"> • Rinsing of some items (OPTIONAL). • Light and moderately soiled items. • Non-colorfast or dark colors. • Permanent press. • Silks, woolens, nylon, acrylic. 	<ul style="list-style-type: none"> • Reduces wrinkling in permanent press fabrics. • Less fading. • Reduces shrinking in knits.
COLD (approx. 65° F)	<ul style="list-style-type: none"> • Rinsing of most items. • Non-colorfast fabrics. • Extra sensitive clothing. 	<ul style="list-style-type: none"> • Saves energy. • Reduces color fading. • Reduces wrinkling. • Reduces shrinking.

Optional Features . . .

Bleach Dispenser

The bleach dispenser is located in the left front corner, under the loading door.

Use liquid bleach in the dispenser. Powdered bleach must not be used in the dispenser. Add powdered bleach to the wash water.

Use no more than one cup chlorine bleach for large loads, three-quarters cup for medium and one-half cup for small loads.

Carefully pour recommended amount of bleach into the dispenser during the first fill of the washer.

Be careful not to spill undiluted bleach. It is a strong chemical and can damage some fabrics if it is not properly diluted.

Fabric Softener Dispenser

To Use Dispenser

After the clothes are loaded into the washtub and before the start of the WASH cycle, pour the proper amount of liquid fabric softener into the bottle measuring cap (see bottle directions). Pour into dispenser.

The large fabric softener dispenser allows for the fabric softener to be diluted with water. We recommend adding water up to the fill level. Do not exceed tip of arrow which indicates correct fill level. Over-filling can allow fabric softener to spill onto the clothes.

Setting the water level to medium or higher will result in better performance from the fabric softener.

The fabric softener will remain in the dispenser during the wash fill, agitation and spin. At the end of the wash spin, the liquid fabric softener will be dispensed into the washtub through the slots in the agitator and will be mixed with the incoming rinse water.

To Clean The Dispenser

Remove the dispenser housing from agitator by squeezing the lower part of the dispenser, pulling directly upward and at the same time tilting slightly. This will expose the dispenser cup, which is also removable for cleaning (refer to illustration). Both housing and cup can be soaked in hot soapy water and rinsed clean. The funnel shape in top of agitator also needs to be cleaned. The hole and the slots in the two rings will require using a small brush for proper cleaning.

After cleaning, install dispenser cup, then push dispenser housing directly downward onto top of agitator until firmly snapped together.

Use Tips

- Fabric softener spilled onto garments may cause staining. To remove, soak in a soapy solution made from Sard Wonder Soap or rub the stain with a bar of Sard, then wash.
- Liquid fabric softeners will be dispensed during the final rinse and should not be combined with bleach, bluing, starch, detergents, soaps or packaged water conditioners during this rinse.
- Fabric softener is not to be used in dispenser when using Prewash cycle, if available.
- When adding detergent to wash water, do not allow any to enter into softener dispenser cup, as softener will become gummy.

To prevent softener buildup, the dispenser can be filled with clean water for automatic cleaning. This can be done in washing cycles other than when softener is used.

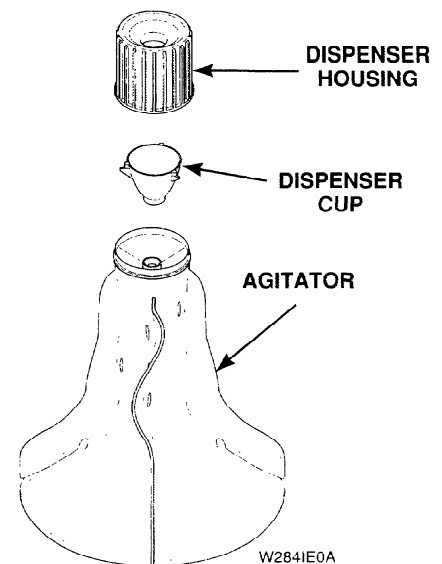

Agitator Cap

IMPORTANT: If your washer comes with an agitator cap, the cap must be on at all times.

Special Care . . .

Starching

Starching adds crispness and body to fabrics, enhances soil resistance, and makes ironing easier. There are several types of starches. Carefully follow label directions for spray or hand starching or starching in the washer.

Knits

A variety of knits are used for many types of clothing and household furnishings. Many knits are machine washable, some are hand washable, and some must be dry-cleaned. When buying, make sure the garment has a care label with care instructions. These directions must be followed. Some knits are stretched during their manufacture and may shrink or relax when exposed to water.

Cotton Knits

Unless the label indicates that it is preshrunk, cotton knits will probably shrink to some degree. Overdrying contributes to shrinkage of cotton knits. Wash water should be hot or warm suitable for color and soil. The rinse water should be cold.

Rayon Knits

Rayon stretches and shrinks easily. Treat as a delicate fabric and wash gently.

Synthetic Fiber Knits

Knits made from synthetic fibers or blends containing a high percentage of synthetics will generally keep their shape. When buying, make sure the trimmings (including belts) are machine washable, seams are not puckered, and zippers and trimmings are well fastened.

Knits of Man-Made Fibers

In general, follow the rules for permanent press fabrics as they tend to have the same characteristics. Set machine to PERMANENT PRESS/KNITS cycle. Set the wash water warm, or suitable for color and soil. Rinse water should be cold. Do not wash with lint-shedding fabrics. Separate items for color, washing whites separately.

Sweaters of Man-Made Fibers

Follow directions for comparable knits. Button sweaters and turn inside out. The ribbon behind the buttons and button holes may shrink. Stretch to shape after washing. Orlon sweaters may stretch. Avoid pulling them when wet. Dryer dry.

Wool Sweaters

Loosely knit or delicately constructed sweaters will need delicate care. Hand wash. Measure garment before and after washing. Squeeze gently through the water with little motion. Rinse thoroughly. Block to shape and dry flat.

For sweaters labeled "machine washable", follow manufacturer's directions. Dry flat. Excess agitation and excess tumbling are the main causes of wool shrinkage.

Wool Knits

Dry-clean wool knits unless labeled machine washable. Follow manufacturer's directions.

(continued)

Permanent Press

Permanent or durable press garments and household items will usually not need pressing when washed and dried properly. However, some will be more wrinkle resistant than others.

The care needed for permanent press is a little different than for cottons. Permanent press garments will soften or become pliable when heated. This softening when it is in warm or hot wash water will allow wear wrinkles to be removed. It will also cause the fabric to wrinkle if it is crushed, squeezed or spun when hot.

How To Wash Permanent Press

1. Wash often. Permanent press clothes tend to look clean even when they should be washed.
2. Sort loads correctly, refer to Page 5.
3. Do not wash with lint-shedding loads. Permanent press attracts lint in the wash water.
4. Pre-treat grease stains and oily areas. This is especially important for shirt collars and cuffs. Rub liquid detergent or a paste of detergent into the area.
5. Use the PERMANENT PRESS/KNITS cycle, hot or warm water, cold rinse, and sufficient detergent.
6. Use fabric softener in the rinse water. This will reduce the static electricity which attracts lint and makes garments cling.

To Dry Permanent Press

For best results, permanent press should be dryer dried. See garment care labels. Ironing may be necessary. Use low heat setting on iron or steam setting on a steam iron.

Washing Special Items . . .

Always Follow Manufacturer's Care Label Instructions

Bedding	<ul style="list-style-type: none"> • Warm wash and warm rinse if available. • PERMANENT PRESS/KNITS cycle. • Pretreat heavily soiled areas before washing. • When washing an electric blanket, protect the plug by stitching the edge of the blanket over the plug. Only dryer dry if manufacturer says it can be done.
Diapers	<ul style="list-style-type: none"> • Rinse out diapers immediately in cold water and soak in a diaper pail with a small amount of detergent or enzyme presoak. Soak before washing. • Limit wash load to two dozen diapers. • Recommend an all-purpose detergent.
Draperies, Curtains, Slip Covers	<ul style="list-style-type: none"> • Shake to remove dust. Remove hooks and close zippers. • Sun-damaged draperies and curtains will not withstand washing. • Use warm water. • Wash curtains frequently. They can be weakened from soil, fumes, dust, and the sun. • Fiberglass curtains need gentle care. Read care label to see if washable. Some fiberglass curtains should be hand washed.
Pillows (Feather and Down)	<ul style="list-style-type: none"> • Do not wash pillows unless they can be dryer dried. They may mildew if not dried completely. • Wash two pillows at a time or add towels for balance. • Use warm wash and cold rinse.
Rugs	<ul style="list-style-type: none"> • Shake before washing. Do not use hot water on rubber-backed rugs. • Wash two or three rugs to balance the washer.
Slips and Nightgowns	<ul style="list-style-type: none"> • Wash often using all-purpose detergent, warm or hot water and cold rinse on the PERMANENT PRESS/KNITS cycle. • To keep nylons and polyesters white, wash only with whites and use chlorine bleach occasionally. • Use fabric softener in the rinse to remove static electricity.

Washing Problems . . .

To keep clothes looking white or bright, use good washing practices at all times to prevent a gradual build-up of soil or water hardness minerals on them. If you notice that your clothes are not as bright as they should be, take corrective measures immediately.

Problem	Cause	Solution
Gray or Dingy Clothes	Insufficient Detergent	Add more detergent to washtub before loading clothes. Mild detergents are not suitable for average soil.
	Improper Sorting	Wash whites separately. Separate light from heavily soiled items. Clothes can pick up soil from dirty wash water.
	Nonphosphate Detergent and Hard Water	Follow package directions. Soften water if possible.
	Water Not Hot Enough	White clothes will stay whiter with hot wash water. Increase temperature.
	Overcrowding Washer	Clothes must circulate freely through the water for best results.
Yellowed Clothes	Unremoved Soil	Skin soil is hard to remove. Check hem edge of sheets and pillowcases, bottom end of t-shirts, etc. If this portion is white and center is yellow, the fabric contains unremoved soil. Use sufficient detergent and a hot wash. Chlorine bleach may be needed.
	Clothes Stained From Iron In The Water	To test if an iron stain, use a rust remover on a portion of the garment. Follow bottle directions for larger items.
	Older Clothes	Some white fabrics turn yellow with age and cannot be whitened.
Clothes Tearing or Damage	Improper Use of Chlorine Bleach	No correction for bleach damaged clothes. Always measure and dilute bleach.
	Overcrowding or Overloading	Make sure all items can move freely during agitation.
	Insufficient Pre-care	Fasten all hooks and zippers. Mend tears. Remove objects from pockets.
Excessive Lint	Improper Sorting	Fabrics which shed lint cannot be washed with fabrics that receive lint.
	Insufficient Detergent / Non-phosphate Detergent	Use enough detergent so lint remains suspended in water and flushed out.
	Mixing Fabric Types	Knits and Permanent Press attract lint. Wash these only with similar items. Use fabric softener in rinse water.

Stain Removal . . .

Many soils will not become stains if treated promptly. Older stains may be difficult or impossible to remove. Hot water will set some stains, particularly protein based stains. Use cold or warm water on these before washing in hot water.



WARNING

Never put highly flammable substances like gasoline, kerosene, waxes, cooking oils, etc. into a washer or dryer. Never put articles that have been cleaned with such substances into a washer or dryer. Failure to comply with these warnings could result in a fire, explosion, and/or serious burns or death. All items with these substances on them should be thoroughly hand-washed with a detergent so that no trace of the flammable substances remains. The articles can then be machine washed and/or dried.

When using any kind of a dry-cleaning fluid, follow the manufacturer's recommendations. The fumes should never be inhaled. Use in a well ventilated room away from sparks and flames. Air dry before washing or drying. Dry-cleaning fluid may cause a "ring" to be formed on some permanent press fabrics. This will not wash out. To remove, clean the garment in a coin-operated dry-cleaning unit, or by a professional dry-cleaner.

W024

Stain	Treatment
Adhesive Tape	Place face down on paper towels and sponge with a dry-cleaning solvent (see WARNING above). Launder.
Airplane Glue	Place face down on paper towels and sponge with fingernail polish remover until stain dissolves. Launder.
Alcoholic Beverages	Sponge stain immediately with cold water or soak stain 30 minutes in cold water. Apply detergent to any trace of stain while still wet. If safe for the fabric, launder in hot water using chlorine bleach.
Blood	Treat stain immediately. Soak 30 minutes or more in cold water. Rub detergent into stain. If stain persists, place a small amount of household ammonia on the stain and rub again with detergent. If safe for fabric, launder in hot water and chlorine bleach if traces of the stain persist.
Candlewax	Rub with ice and scrape off excess wax. Place stain between paper towels and press with warm iron. Then place stain face down on paper towels and sponge with dry-cleaning solvent (see WARNING above). Let dry, launder. If traces of color remain, launder with a commercial color remover or if safe for the fabric, hot water and chlorine bleach.
Catsup, Tomato-Based Products	Scrape off excess. Soak in cold water 30 minutes. Rub detergent into the stain and if safe for fabric, launder in hot water and chlorine bleach.
Chewing Gum	Rub with ice and scrape off excess gum. Place face down on paper towels and sponge with a dry-cleaning solvent.
Cocoa or Chocolate	Soak in cold water. Rub detergent into stain, rinse. If greasy stain remains, sponge face down on paper towels with a dry-cleaning solvent. If traces of the stain remains, launder in hot water and chlorine bleach (if safe for fabric).
Coffee, Tea	Soak in cold water. Rub detergent into stain, rinse. If traces of the stain remain, launder in hot water with chlorine bleach (if safe for fabric).
Crayon	Treat the same as candle wax (above) or wash in hot water (if safe for fabric) using soap (not a detergent) and 1-2 cups baking soda. If stains remain, professional dry-cleaning may be necessary.

(continued)

Stain	Treatment
Deodorants and Anti-Perspirants	Some of these products contain substances that can change the color of some dyes. The color can sometimes be restored if the area is sponged with ammonia then rinsed. To remove stains, apply white vinegar. Rub, rinse. If stains remain, rub detergent into stain and launder with hot water and chlorine bleach (if safe for fabric).
Dye	Treat with a commercial dye remover (Rit, Putnam) or if safe for fabric, bleach with chlorine bleach.
Egg	If dried, scrape off excess. Soak in cold water. Rub detergent into damp stain and if safe for fabric, launder in hot water and chlorine bleach.
Fabric Softener	Dampen stain and rub with bar soap. Launder as usual.
Fruit Juices	Soak in cold water. Launder in hot water with chlorine bleach (if safe for fabric).
Grease, Oil	Place face down on paper towel and sponge with dry-cleaning fluid (see WARNING on Page 15). Dampen stain with water and rub with bar soap or detergent. Launder in hot water (if safe for fabric).
Ink	Saturate the stain with hair spray or place the fabric face down on paper towel and sponge with cleaning fluid or rubbing alcohol (see WARNING on Page 15). Rinse. If traces of the stain remain, rub detergent into the dampened stain and launder. Some inks may be impossible to remove.
Iodine	Rinse from the back side of the stain with cold water. Then soak in a commercial color remover (Rit, Putnam, etc.) or rub in a paste of water and starch. Let stand for 15-30 minutes and launder.
Lipstick	Place on paper towel and sponge with cleaning fluid (see WARNING on Page 15). Rinse. Rub dampened stain with bar soap and launder.
Mildew	Treat promptly. Mildew damages fabric and sometimes cannot be removed. Launder with chlorine bleach. For items that cannot be washed with chlorine bleach, soak in an all-fabric bleach, then launder.
Milk and Milk Products	Soak in cold water. Launder in hot water and chlorine bleach (if safe for fabric). Sponge with a cleaning fluid (see WARNING on Page 15), if a stain is noticeable. Rewash.
Miscellaneous Eye and Face Make-up, Tar, Gravy, Felt-Tip Marker, Pitch, Typewriter Ribbon	Place stain side down on paper towel and sponge with dry-cleaning fluid (see WARNING on Page 15). Apply dry spotter (one part mineral water and eight parts dry-cleaning solvent). Use a spoon to loosen stain. Keep stain moist with dry spotter and blot occasionally with toweling. Continue until stain is removed. Allow to dry completely, rinse in warm water, and launder as usual.
Mud	Scrape off excess. Soak in solution of one quart warm water, half teaspoon liquid hand dishwashing detergent and one tablespoon vinegar for 15 minutes. Rinse. Launder in hot or warm water with enzyme product.
Mustard	Rub dampened stain with bar soap. Launder in hot water and chlorine bleach (if safe for fabric).
Nail Polish	Place face down on paper towel. Sponge with nail polish remover (non-oily) until stain disappears. Launder. Do not use nail polish remover on Acetate or Arnel fabrics.

Stain	Treatment
Paint	Water-based -- Treat by rinsing fabric in cool water while stains are still wet. Then launder. Dried paint cannot be removed. Oil-based -- Pretreat with a solvent recommended on the paint container. If not available, use mineral spirits. Rinse. Pretreat with a stain remover or detergent, rinse and launder.
Perspiration	Rub dampened stain with detergent. Launder in hot water and chlorine bleach (if safe for fabric). If the fabric is discolored, you can try to restore it by treating fresh stains with ammonia or old stains with vinegar.
Rust	Apply a commercial rust remover (Whink, Rit, RoVer, etc.) Follow manufacturer's directions. Then launder as usual.
Scorching	Launder using hot water and chlorine bleach (if safe for fabric). Fabrics can be damaged by being scorched. If this has happened, you may not be able to remove the marks.
Shoe Polish	Rub dampened stain with detergent. Launder in hot water and chlorine bleach if safe for fabric.
Soft Drinks	Rinse stain with cold water immediately. Launder in warm water and chlorine bleach if safe for fabric.
Tobacco	Dampen stain and rub with bar soap. Rinse. If necessary, soak in an all-fabric bleach solution. If stain remains, launder with chlorine bleach (if safe for fabric).
Urine	Rinse with cold water. Soak with an enzyme soaking product. Launder in hot water with chlorine bleach (if safe for fabric). If the color of the fabric has changed, sponging the area with ammonia may restore the color.
Vomit	Soak in a solution of one quart warm water, half teaspoon liquid hand dishwashing detergent, and one tablespoon ammonia (if safe for fabric). Soak 15 minutes. Use sponge to loosen stain. Blot with toweling. Launder in hot water (if safe for fabric) with an enzyme product.

Maintenance . . .

Cold Weather Care

If the washer is delivered on a cold day (below freezing), or is stored in an unheated room or area during the cold months, do not attempt to operate it until the washer has had a chance to warm up.

Care Of Your Washer

Use only a damp or sudsy cloth for cleaning the control panel. Some spray prewash products may harm the finish on the control panel.

Wipe the washer cabinet as needed. If detergent, bleach or other washing products are spilled on the cabinet, wipe immediately. Some products will cause permanent damage if spilled on the cabinet.

Do not use scouring pads or abrasive cleansers.

Do not lay sharp or rough objects on or against the washer. The finish could be damaged.

The washtub will need no particular care though it may need rinsing or wiping after an unusual load has been washed. This also may be necessary if too little detergent has been used.

Leave the loading door open to allow the inside of the washer to dry out after use. This helps prevent musty odors from developing.

Vacations and Extended Non-Use

IMPORTANT: To avoid possible property damage due to flooding, turn off the water supply to the washer whenever there will be an extended period of non-use.

Reinstallation of Shipping Materials

Shipping Brace

The corrugated shipping brace should be saved and reinstalled whenever the washer is moved. To reinstall the brace, open the washer lid and place the brace over the washer agitator, placing the back of the brace into the washtub first.

Shipping Plug

The plastic shipping plug should be saved and reinstalled any time the washer is moved. The plug fits into two openings: The base opening and the shipping plug opening on the bottom of the mobile pivot dome. The plug **MUST** be inserted into both openings to prevent damage to the washer. In order to accomplish this, the shipping plug opening must be directly lined up with the base opening. See illustration below.

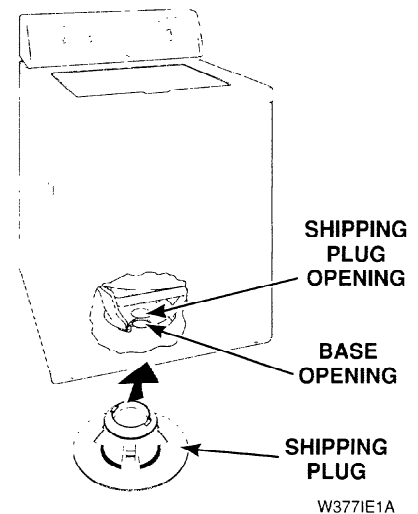

Motor Overload Protector . . .

This internal overload protector will stop the motor automatically in the event of an overload. The overload protector will reset itself

in two or three minutes and the motor will restart automatically. If the overload protector stops the

motor again, remove the washer from use and call the service person to correct the problem.

Before You Call For Service . . .

• **If Your Washer:**

Won't Fill	Won't Start	Won't Agitate	Won't Spin	Possible Reason — Do This To Correct
•	•	•	•	Be sure the power cord is plugged all the way into the electrical outlet.
	•	•	•	Close the loading door.
•	•	•	•	Check the house fuse or circuit breaker.
	•	•	•	Has the motor overload protector cycled?
•				Turn on the hot and cold water faucets.
•	•	•	•	Pull timer knob out to start the washer.
•				Was the last spin completed?
•				Clean the filter screens located at the faucet end of the inlet hoses. Owner is responsible for service call regarding cleaning of the screens.
•				Water is siphoned from the washer during the cycle. Refer to the INSTALLATION INSTRUCTIONS supplied with the washer.
•	•			Are the controls properly set?
		•	•	Broken drive belt. Call the serviceman.

If Service Is Required . . .

If service is required, contact the nearest Factory Authorized Service Center.

If you are unable to locate an authorized service center or are unsatisfied with the service performed on your washer, contact:

Amana Appliances
2800 220th Trail
P.O. Box 8901
Amana, Iowa 52204-0001
Phone: 1-800-843-0304 In USA
(319) 622-5511 Outside USA
FAX: (319) 622-2977

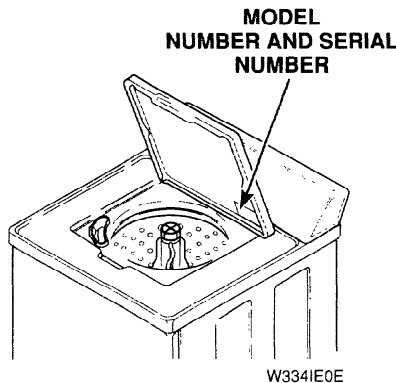

When calling or writing about your washer, PLEASE GIVE THE MODEL AND SERIAL NUMBERS. The model and serial numbers are located on the nameplate. The nameplate will be in the location shown. Please include a copy of your bill of sale and any service receipts you have.

	WARNING
<p>To reduce the risk of serious injury or death, DO NOT repair or replace any part of the washer or attempt any servicing unless specifically recommended in the user-maintenance instructions or in published user-repair instructions that you understand and have the skills to carry out.</p>	
W025	

Factory Service Centers . . .

Listed below are Factory Service Centers which service most metropolitan and surrounding areas. Amana also has a network of independent authorized technicians. Locate a Factory Service Center or independent authorized Amana service technician by calling **1-800-628-5782** inside USA and **319-622-5511** outside USA. When contacting Amana provide product information (locate product information on the nameplate). Warranty service must be performed by an **authorized** Amana technician. Amana also recommends contacting an **authorized** Amana technician if service is required after warranty expires.

Amana Factory Service Center Arizona

Also dispatches service in areas of Nevada

Amana Factory Service Center Southern California

Also dispatches service in areas of Oregon and Washington

Amana Factory Service Center Colorado

Also dispatches service in areas on Utah

Amana Factory Service Center Florida

Amana Factory Service Center Georgia

Also dispatches service in areas of Alabama, North Carolina, South Carolina, and Tennessee

Amana Factory Service Center Iowa

Also dispatches service in areas of Kansas, Minnesota, Missouri, and Wisconsin

Amana Factory Service Center Illinois

Also dispatches service in areas of Indiana and Kentucky

Amana Factory Service Center Massachusetts

Also dispatches service in areas of New Hampshire and Rhode Island

Amana Factory Service Center Maryland

Also dispatches service in areas of Pennsylvania, Virginia, and Washington, D.C.

Amana Factory Service Center New York

Also dispatches service in areas of Connecticut and New Jersey

Amana Factory Service Center Ohio

Also dispatches service in areas of Michigan and Pennsylvania

Amana Factory Service Center Texas



Amana offers long-term service protection for this new appliance. Asure™ Extended Service Plan is specially designed to supplement Amana's strong warranty. Once we have received your registration card, you will receive coverage and pricing information in the mail. This plan covers functional parts, labor and travel charges. Call **1-800-528-2682** if you have any questions. This service plan is only available in USA.

Information For Handy Reference . . .

Amana Appliances
2800 220th Trail
P.O. Box 8901
Amana, Iowa 52204-0001

Date Purchased _____

Model Number _____ Serial Number _____

Dealer's Name _____

Dealer's Address _____ Phone Number _____

Service Agency _____

Service Agency Address _____ Phone Number _____

Record this information and keep your sales slip. Model and serial numbers are located on the nameplate.